

WRC Prosper Celadna

Mladez Hunt Seat Equitation

Show Date: 09-03-2022

www.HorseShowPatterns.com

www.HorseShowPatterns.com

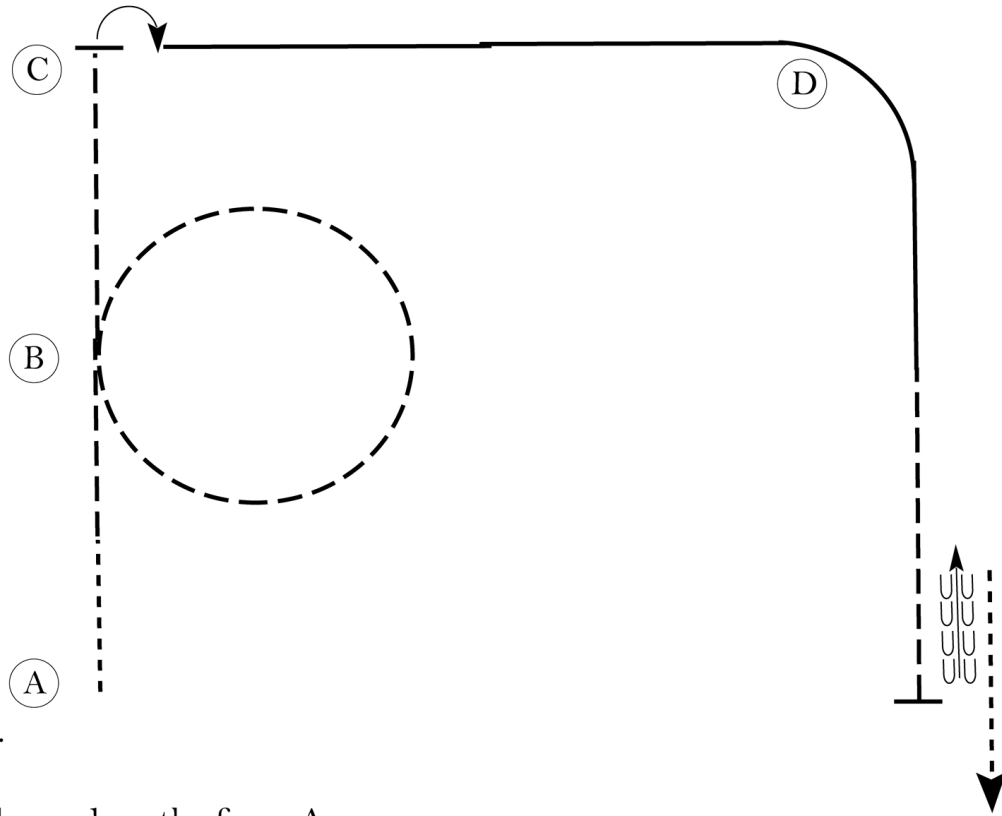

Be ready at A.

1. Walk two horse lengths from A.
2. Sitting trot to B.
3. At B, trot a circle to the right on the left diagonal.
4. Continue trot to C.
5. Stop at C and perform a 90 degree turn on the hindquarters to the right.
6. Canter on the right lead to and around D.
7. When even with B, begin a posting trot on the right diagonal.
8. Stop when even with A and back approximately one horse length.

Walk away from D and follow the instructions of your ring steward.

Walk	-----
Trot	- - - - -
Extended Trot	-----
Canter	—————
Leg Yield	
Lead Change	↘ ↙
Back	← ← ← ← ←
Marker	⊙
Sidepass	← — — — →
Hand Gallop	—————

[HSE/1-44]

Pattern Provided by:

Jitka Kynclova

WRC Prosper Celadna

Otevrena Hunt Seat Equitation

Show Date: 09-03-2022

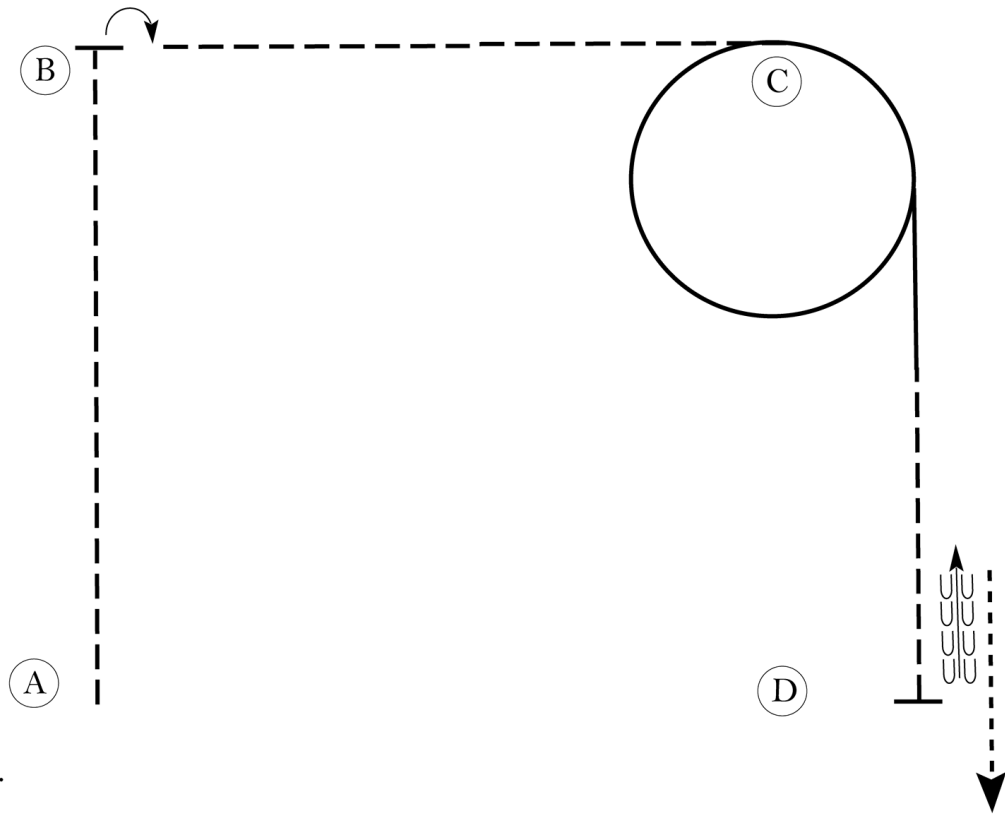

Be ready at A.

1. Sitting trot to B.
2. Stop at B and execute a 90 degree turn on the haunches to the right.
3. Posting trot on the right diagonal to C.
4. Canter on the right lead in a circle around C.
5. Continue on the right lead halfway to D.
6. Posting trot on the left diagonal to D.
7. Stop at D and back approximately one horse length.
8. Walk forward to and past D.

Follow the instructions of your ring steward.

Walk	-----
Trot	- - - - -
Extended Trot	— — — — —
Canter	—————
Leg Yield	
Lead Change	↖ ↗
Back	← ← ← ← ←
Marker	⊙
Sidepass	← — — — — →
Hand Gallop	—— — — —

[HSE/1-43]

Pattern Provided by:

Jitka Kynclova

WRC Prosper Celadna

Mladez Ranch Riding

Show Date: 09-03-2022

www.HorseShowPatterns.com

www.HorseShowPatterns.com

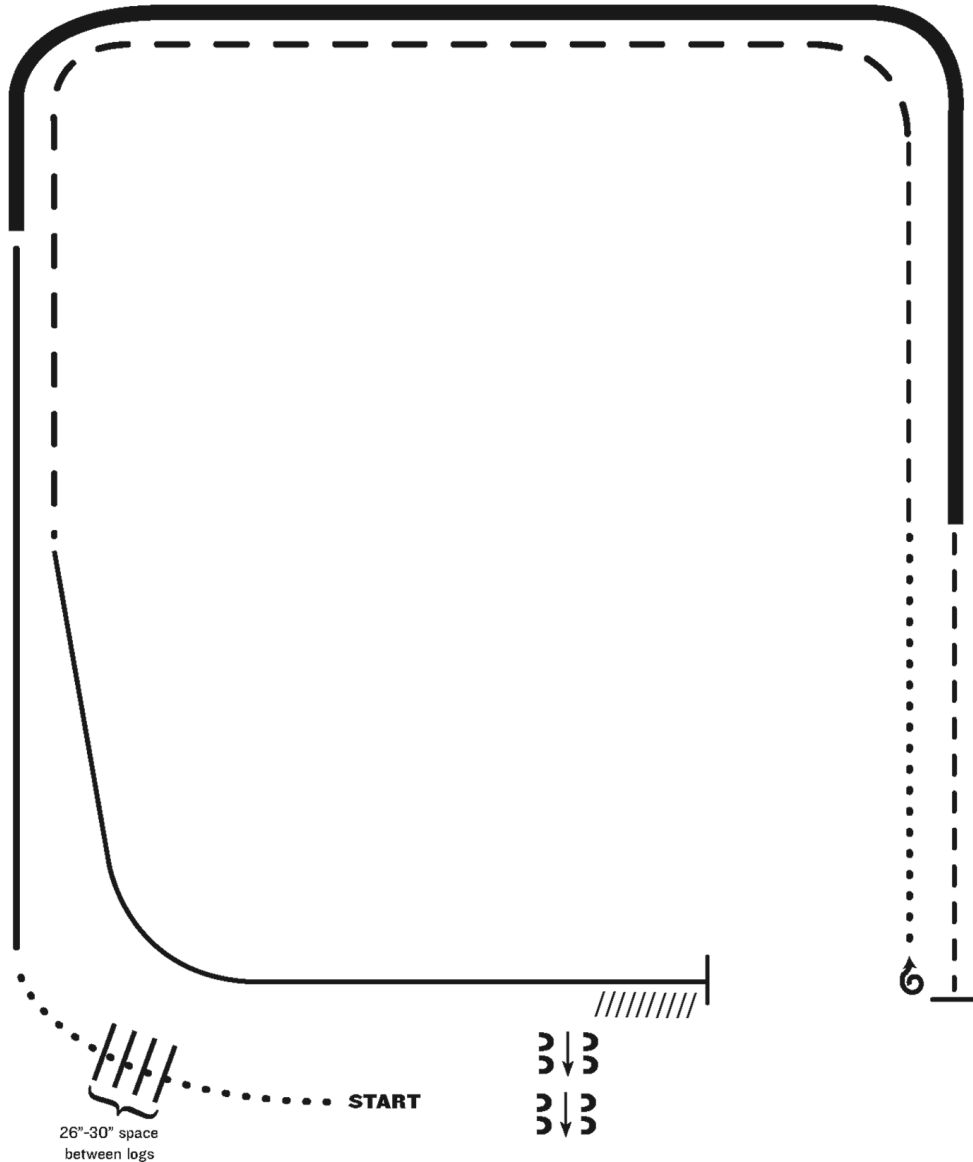

1. Walk
2. Walk over logs
3. Lope right lead
4. Extended lope (right lead)
5. Trot
6. Stop, 1 1/2 turns right
7. Walk
8. Trot
9. Extended trot
10. Lope left lead
11. Stop and Back
12. Side pass right

Note: The drawn description of this pattern is only intended for the general depiction of the pattern. Exhibitors should utilize the arena space to best exhibit their horses.

[RR/AQHA-6]

Pattern Provided by:

Jitka Kynclova

WRC Prosper Celadna

Trail Mladez

Show Date: 09-03-2022

www.HorseShowPatterns.com

www.HorseShowPatterns.com

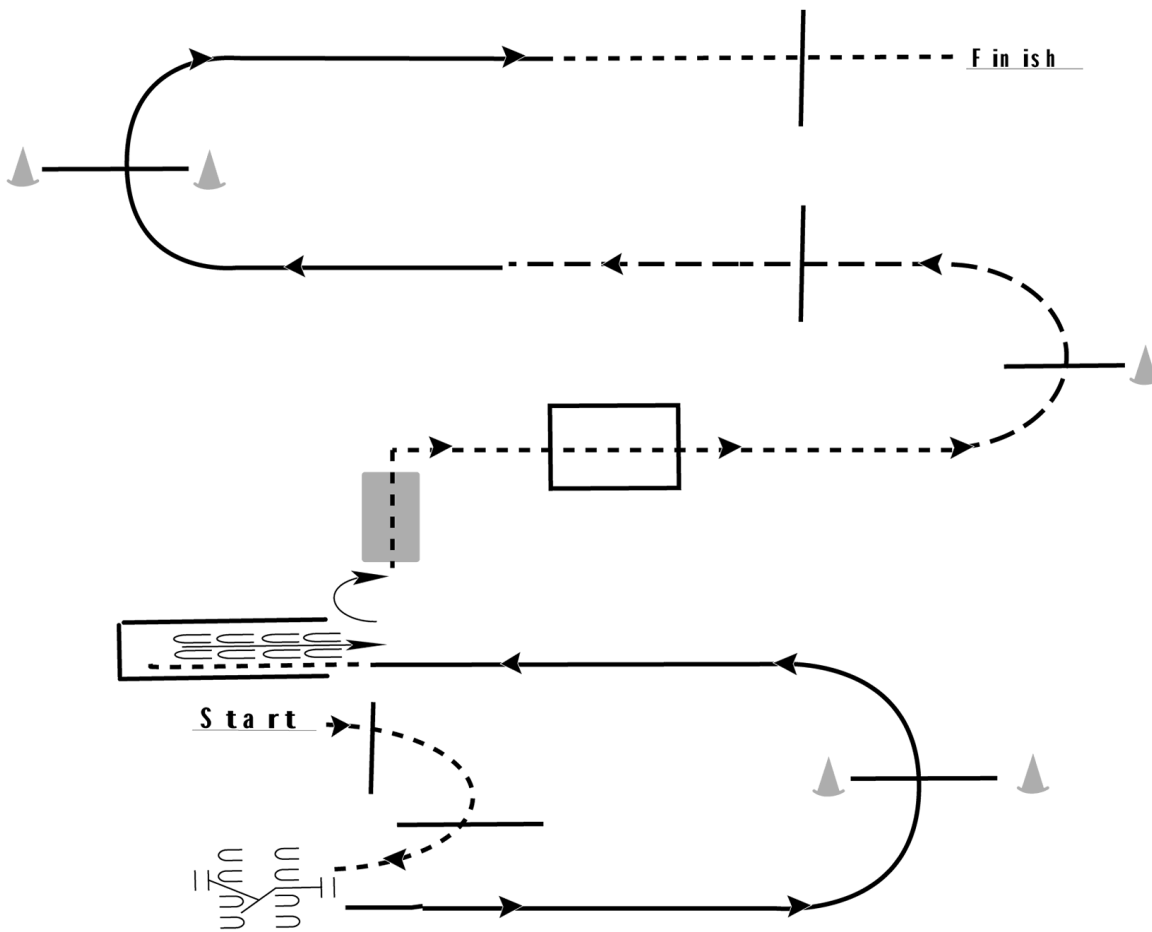

1. Walk over two poles to gate
2. Work gate with left hand
3. Lope on the left lead over pole
4. Break to a walk and walk into chute
5. Back out of chute
6. Walk over bridge
7. Walk through box
8. Trot over poles
9. Lope on the right lead over pole
10. Break to the walk and walk over final elevated pole to finish

Walk	-----
Jog	- - - - -
Extended Jog	- - - - -
Lope	—————
Leg Yield	
Lead Change	— / —
Back	← ← ← ← ←
Marker	(B)
Sidepass	← — — — — ←

[T/1-9]

Pattern Provided by:

Jitka Kynclova

WRC Prosper Celadna

Otevrena Trail Junior

Show Date: 09-03-2022

www.HorseShowPatterns.com

www.HorseShowPatterns.com

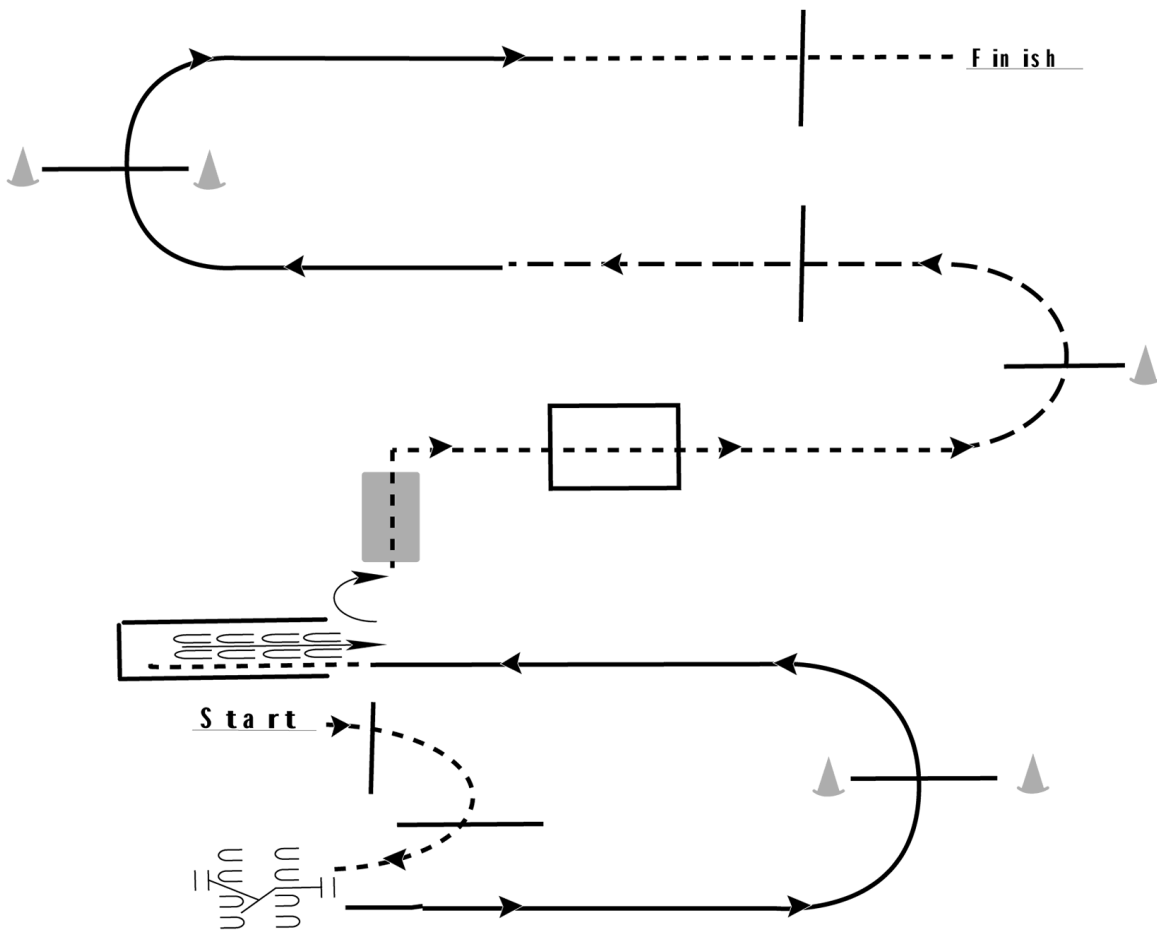

1. Walk over two poles to gate
2. Work gate with left hand
3. Lope on the left lead over pole
4. Break to a walk and walk into chute
5. Back out of chute
6. Walk over bridge
7. Walk through box
8. Trot over poles
9. Lope on the right lead over pole
10. Break to the walk and walk over final elevated pole to finish

Walk	-----
Jog	- - - - -
Extended Jog	- - - - -
Lope	—————
Leg Yield	
Lead Change	↘
Back	←←←←←
Marker	Ⓚ
Sidepass	←-----←

[T/1-9]

Pattern Provided by:

Jitka Kynclova

WRC Prosper Celadna

Amater Trail

Show Date: 09-03-2022

www.HorseShowPatterns.com

www.HorseShowPatterns.com

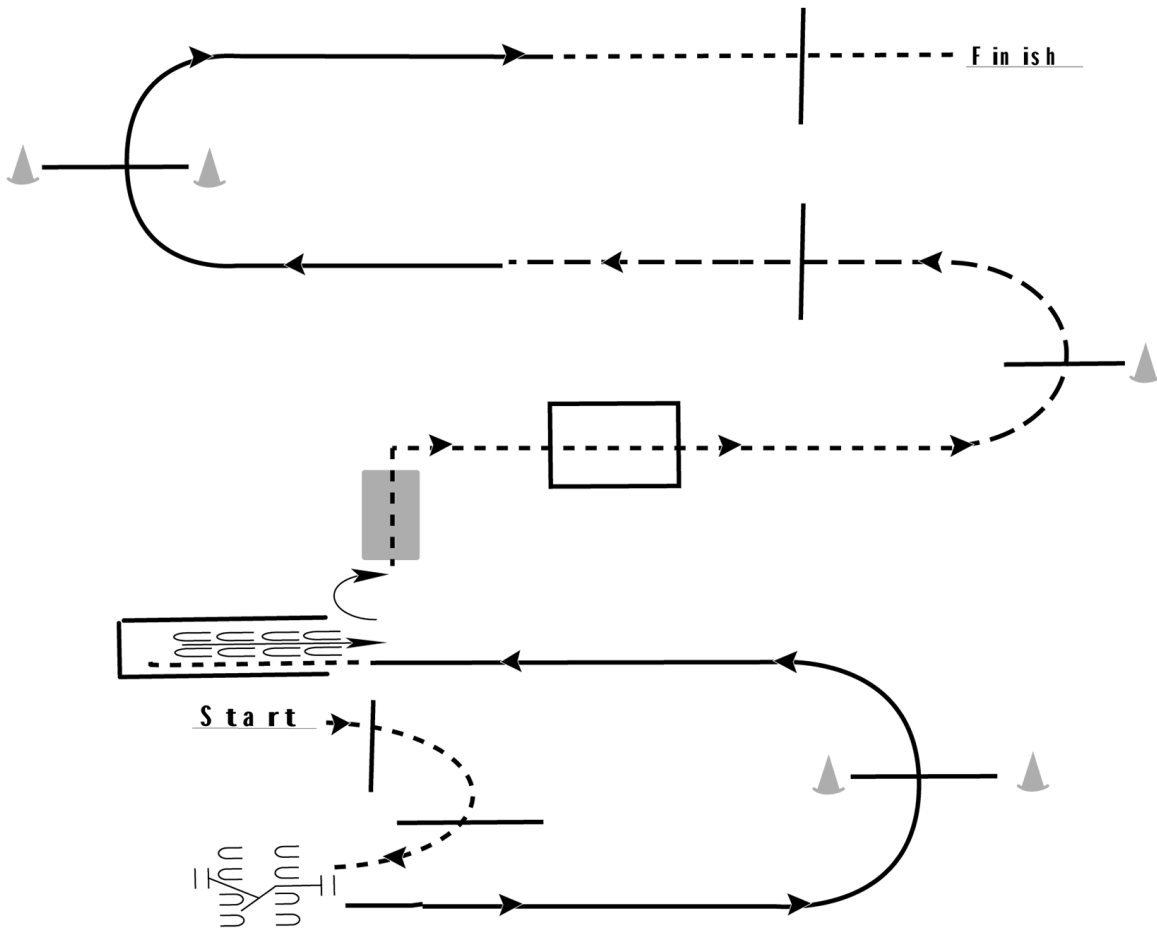

1. Walk over two poles to gate
2. Work gate with left hand
3. Lope on the left lead over pole
4. Break to a walk and walk into chute
5. Back out of chute
6. Walk over bridge
7. Walk through box
8. Trot over poles
9. Lope on the right lead over pole
10. Break to the walk and walk over final elevated pole to finish

Walk	-----
Jog	- - - - -
Extended Jog	- - - - -
Lope	—————
Leg Yield	
Lead Change	— / —
Back	← ← ← ← ←
Marker	Ⓚ
Sidepass	←-----←

[T/1-9]

Pattern Provided by:

Jitka Kynclova

WRC Prosper Celadna

Otevrena Trail Senior ((Prizvednute kavalety))

Show Date: 09-03-2022

www.HorseShowPatterns.com

www.HorseShowPatterns.com

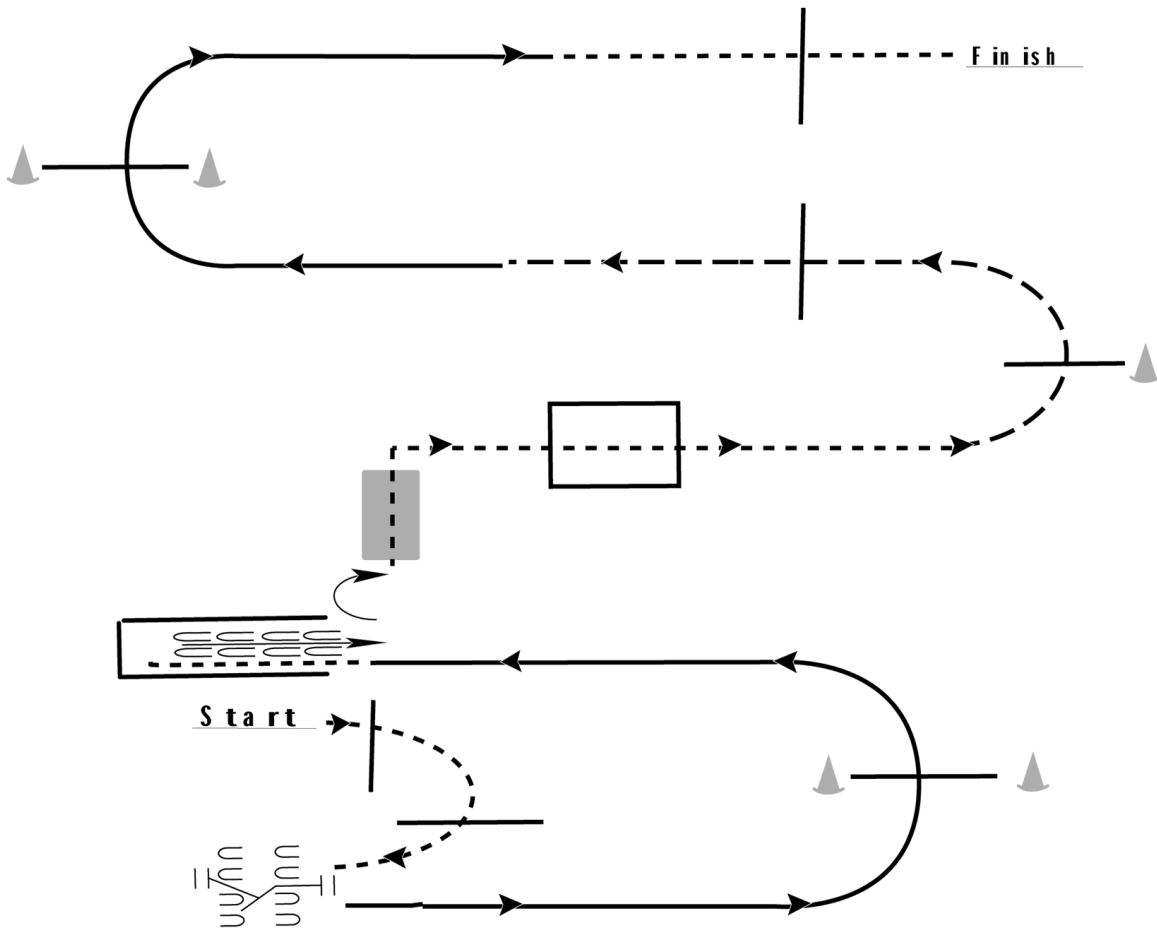

1. Walk over two poles to gate
2. Work gate with left hand
3. Lope on the left lead over pole
4. Break to a walk and walk into chute
5. Back out of chute
6. Walk over bridge
7. Walk through box
8. Trot over poles
9. Lope on the right lead over pole
10. Break to the walk and walk over final elevated pole to finish

Walk	-----
Jog	- - - - -
Extended Jog	- - - - -
Lope	—————
Leg Yield	
Lead Change	— / —
Back	← ← ← ← ←
Marker	(B)
Sidepass	← — — — — ←

[T/1-9]

Pattern Provided by:
Jitka Kynclova

WRC Prosper Celadna

Pidilidi trail (pouze krokem!)

Show Date: 09-03-2022

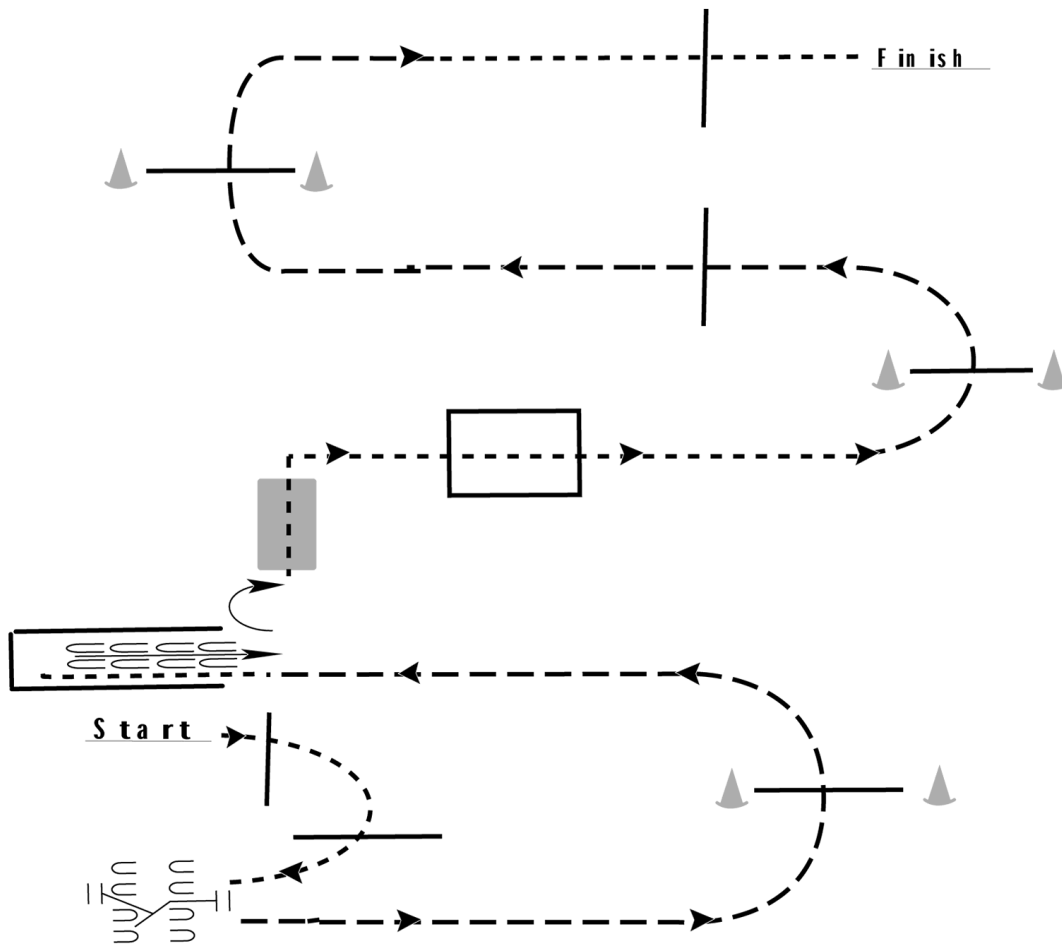

1. Walk over two poles to gate
2. Work gate with left hand
3. Trot over pole to chute
4. Walk into chute
5. Back out of chute
6. Walk over bridge
7. Walk through box
8. Trot over poles
9. Break to the walk and walk over final elevated pole to finish

Walk	-----
Jog	- - - - -
Extended Jog	- - - - -
Lope	—————
Leg Yield	
Lead Change	— / —
Back	← ← ← ← ←
Marker	⊙ B
Sidepass	← ← ← ← ←

[T/WT-9]

Pattern Provided by:

Jitka Kynclova

w w w . H o r s e S h o w P a t t e r n s . c o m

w w w . H o r s e S h o w P a t t e r n s . c o m

WRC Prosper Celadna

Amater Trail in Hand

Show Date: 09-03-2022

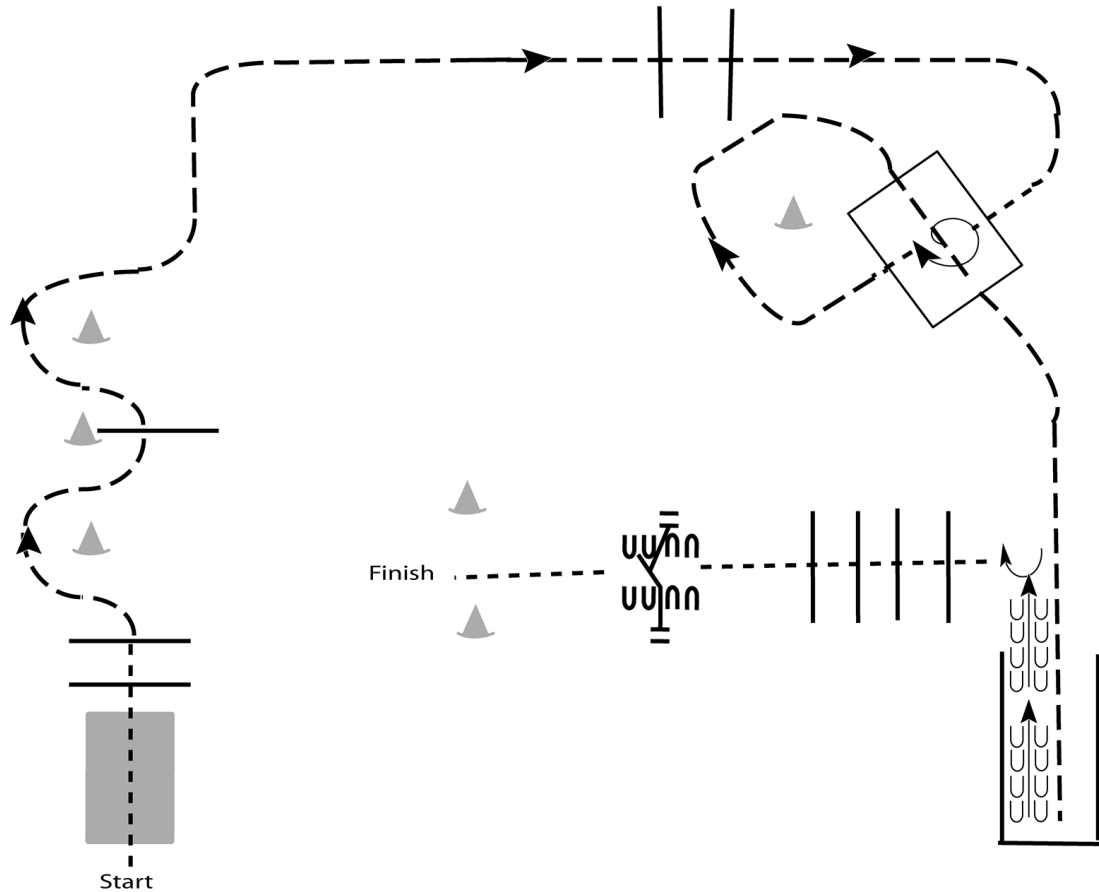

1. Walk over bridge and over poles.
2. Jog through serpentine and over pole.
3. Continue to jog over poles.
4. Break to a walk and walk into box. Turn a full turn to the right and walk out of box.
5. Jog through box and into chute
6. Back out of chute
7. Turn 90 degrees and walk over poles to gate
8. Work gate and walk to finish

Walk	-----
Jog	- - - - -
Extended Jog	- - - - -
Lope	—————
Leg Yield	
Lead Change	— / —
Back	← ← ←
Marker	ⓑ
Sidepass	← — — — — →

[T/1-6]

Pattern Provided by:

Jitka Kynclova

www.HorseShowPatterns.com

www.HorseShowPatterns.com

WRC Prosper Celadna

Otevrena In Hand Trail ((Prizvednute kavalety))

Show Date: 09-03-2022

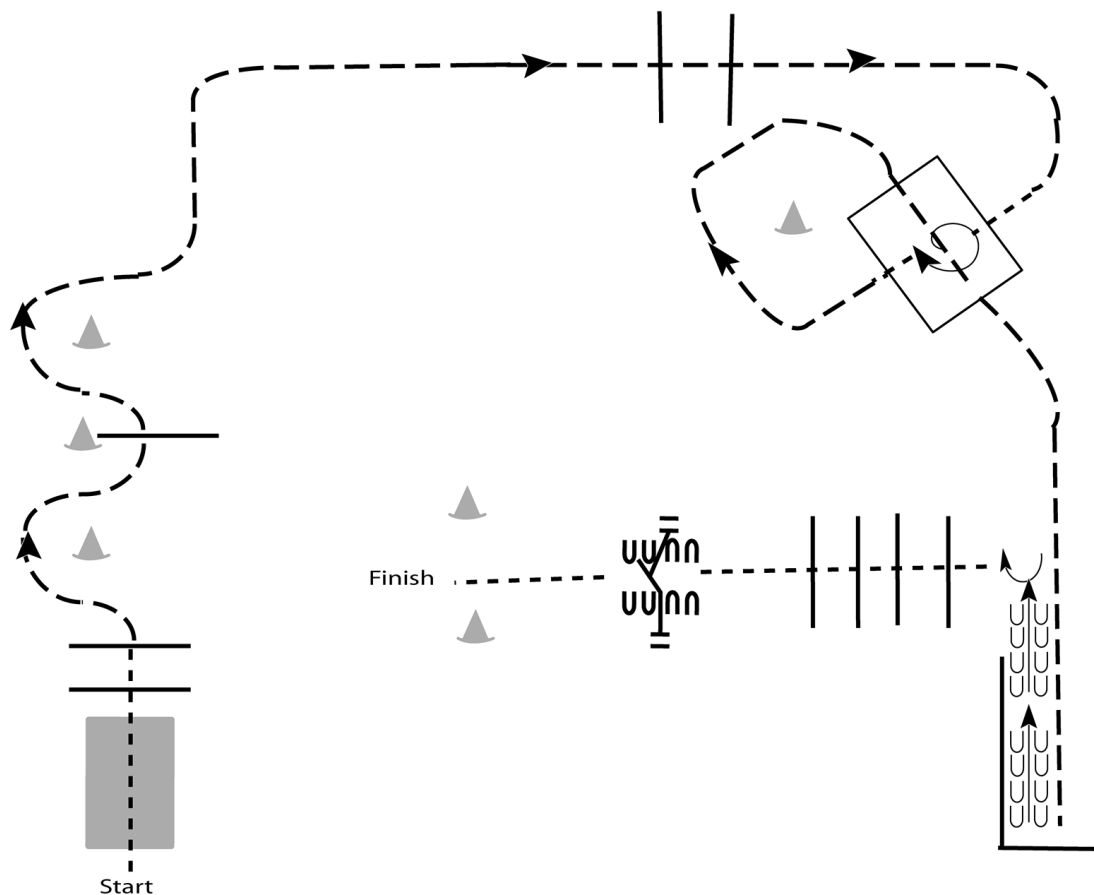

1. Walk over bridge and over poles.
2. Jog through serpentine and over pole.
3. Continue to jog over poles.
4. Break to a walk and walk into box. Turn a full turn to the right and walk out of box.
5. Jog through box and into chute
6. Back out of chute
7. Turn 90 degrees and walk over poles to gate
8. Work gate and walk to finish

Walk	-----
Jog	- - - - -
Extended Jog	- - - - -
Lope	—————
Leg Yield	
Lead Change	— / —
Back	←←←←←
Marker	ⓑ
Sidepass	←-----→

[T/1-6]

Pattern Provided by:

Jitka Kynclova

www.HorseShowPatterns.com

www.HorseShowPatterns.com

WRC Prosper Celadna

Otevrena Ranch Riding

Show Date: 09-03-2022

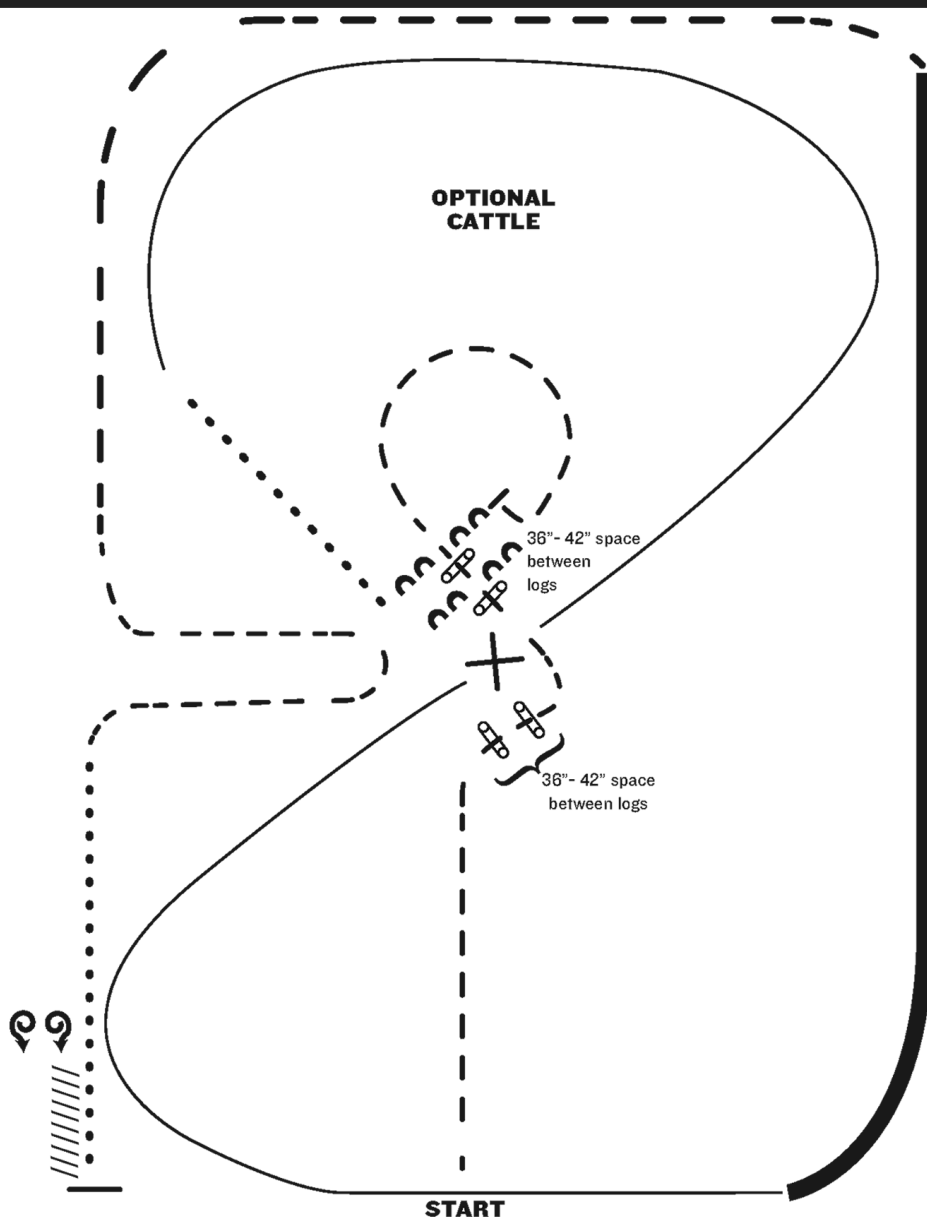

1. Trot
2. Trot two sets of logs
3. Trot circle, stop and side pass log left
4. Walk
5. Lope right lead
6. Change leads (simple or flying)
7. Lope left lead
8. Extended lope (left lead)
9. Extended trot
10. Trot
11. Walk
12. Stop and back
13. 360 degree turn each direction (either direction 1st) (L-R or R-L)

Note: The drawn description of this pattern is only intended for the general depiction of the pattern. Exhibitors should utilize the arena space to best exhibit their horses.

[RR/AQHA-9]

Pattern Provided by:

Jitka Kynclova

WRC Prosper Celadna

Mradez reining

Show Date: 09-03-2022

REINING PATTERN 4

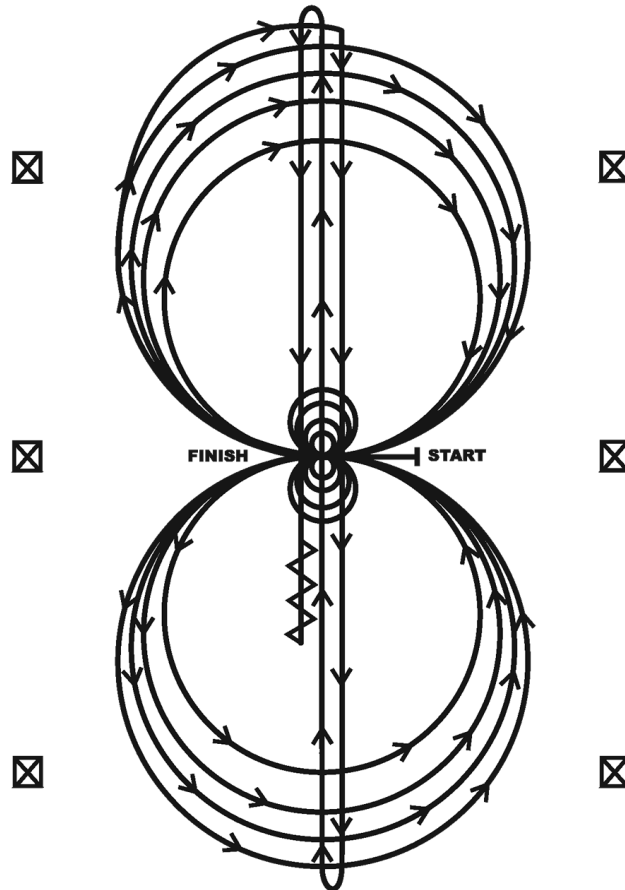

Horses may walk or jog to the center of the arena. Horses must walk or stop prior to starting pattern. Beginning at the center of the arena facing the left wall or fence.

1. Beginning on the right lead, complete three circles to the right: the first two large and fast; the third circle small and slow. Stop at the center of the arena. Hesitate.
2. Complete four spins to the right. Hesitate.
3. Beginning on the left lead, complete three circles to the left: the first two circles large and fast; the third circle small and slow. Stop at the center of the arena. Hesitate.
4. Complete four spins to the left. Hesitate.
5. Beginning on the right lead, run a large fast circle to the right, change leads at the center of the arena, run a large fast circle to the left, and change leads at the center of the arena. (Figure 8)
6. Continue around previous circle to the right. At the top of the circle, run down the middle to the far end of the arena past the end marker and do a right rollback—no hesitation.
7. Run up the middle to the opposite end of the arena past the end marker and do a left rollback—no hesitation.
8. Run past the center marker and do a sliding stop. Back up to the center of the arena or at least ten feet (three meters). Hesitate to demonstrate completion of the pattern.

[R/AQHAP-4]

Pattern Provided by:

Jitka Kynclova

WRC Prosper Celadna

Otevrena reining junior

Show Date: 09-03-2022

REINING PATTERN 4

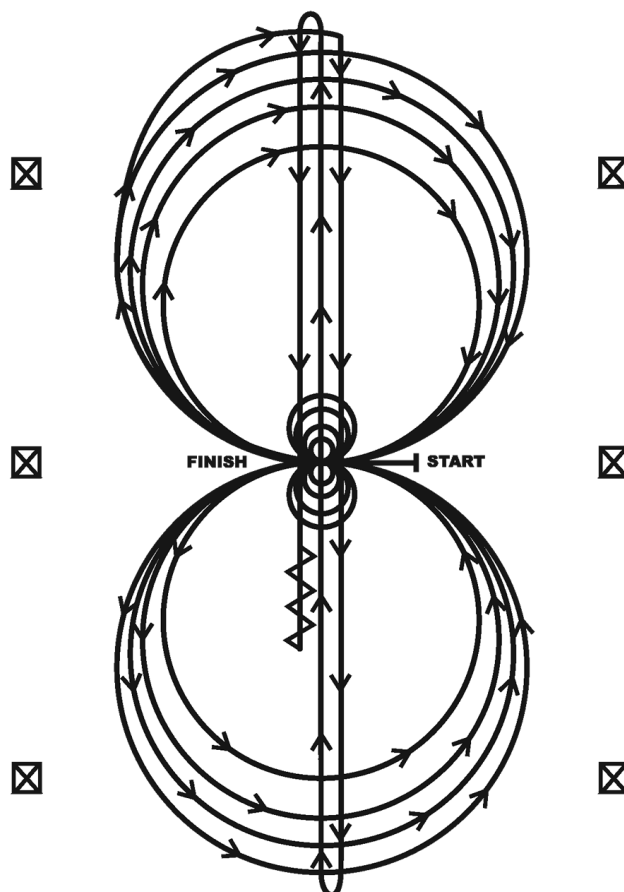

Horses may walk or jog to the center of the arena. Horses must walk or stop prior to starting pattern. Beginning at the center of the arena facing the left wall or fence.

1. Beginning on the right lead, complete three circles to the right: the first two large and fast; the third circle small and slow. Stop at the center of the arena. Hesitate.
2. Complete four spins to the right. Hesitate.
3. Beginning on the left lead, complete three circles to the left: the first two circles large and fast; the third circle small and slow. Stop at the center of the arena. Hesitate.
4. Complete four spins to the left. Hesitate.
5. Beginning on the right lead, run a large fast circle to the right, change leads at the center of the arena, run a large fast circle to the left, and change leads at the center of the arena. (Figure 8)
6. Continue around previous circle to the right. At the top of the circle, run down the middle to the far end of the arena past the end marker and do a right rollback—no hesitation.
7. Run up the middle to the opposite end of the arena past the end marker and do a left rollback—no hesitation.
8. Run past the center marker and do a sliding stop. Back up to the center of the arena or at least ten feet (three meters). Hesitate to demonstrate completion of the pattern.

[R/AQHAP-4]

Pattern Provided by:

Jitka Kynclova

WRC Prosper Celadna

Amater reining

Show Date: 09-03-2022

REINING PATTERN 6

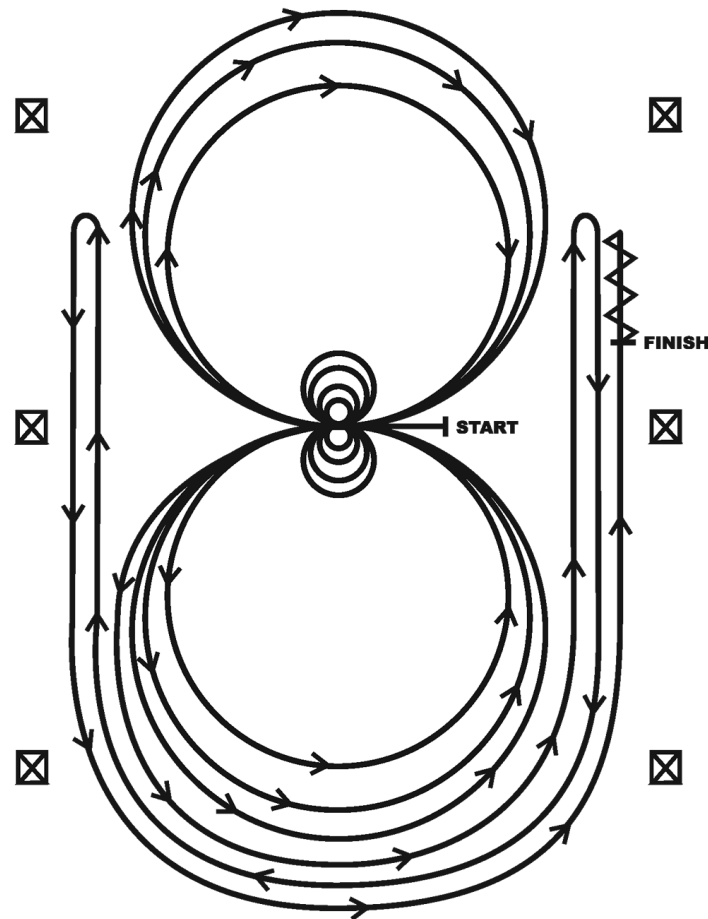

Horses may walk or jog to the center of arena. Horses must walk or stop prior to starting pattern. Beginning at the center of the arena facing the left wall or fence.

1. Complete four spins to the right. Hesitate.
2. Complete four spins to the left. Hesitate.
3. Beginning on the left lead, complete three circles to the left: the first two circles large and fast; the third circle small and slow. Change leads at the center of the arena.
4. Complete three circles to the right: the first two circles large and fast; the third circle small and slow. Change leads at the center of the arena.
5. Begin a large circle to the left but do not close this circle. Run up the right side of the arena past the center marker and do a right rollback at least twenty feet (six meters) from the wall or fence—no hesitation.
6. Continue back around previous circle but do not close this circle. Run up the left side of the arena past the center marker and do a left rollback at least twenty feet (six meters) from the wall or fence—no hesitation.
7. Continue back around previous circle but do not close this circle. Run up the right side of the arena past the center marker and do a sliding stop at least twenty feet (six meters) from the wall or fence. Back up at least ten feet (three meters). Hesitate to demonstrate the completion of the pattern.

[R/AQHAP-6]

Pattern Provided by:

Jitka Kynclova

WRC Prosper Celadna

Otevrena reining senior

Show Date: 09-03-2022

REINING PATTERN 2

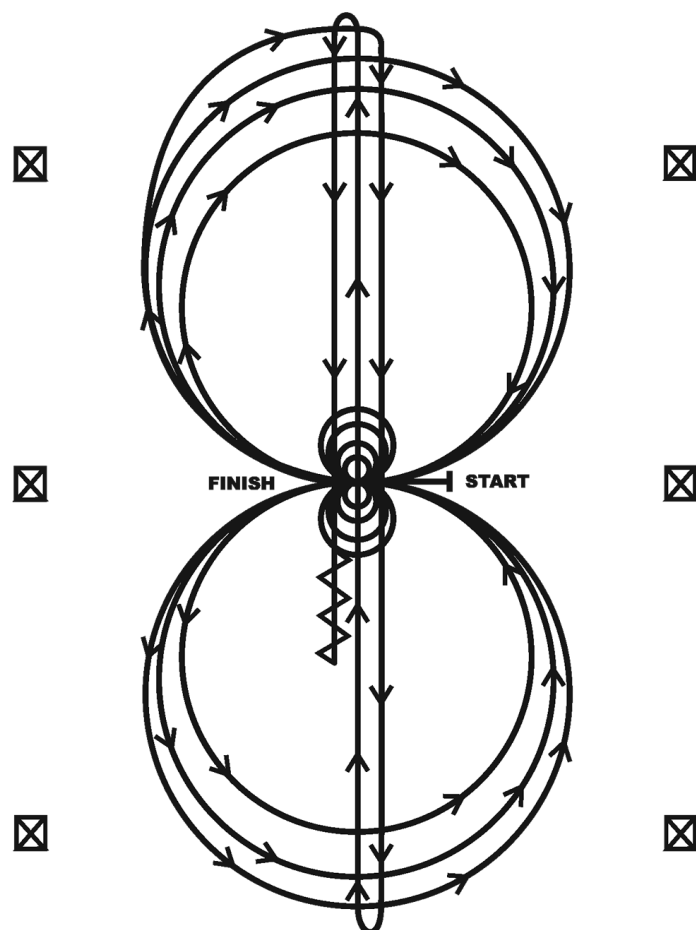

Horses may walk or jog to the center of arena. Horses must walk or stop prior to starting pattern. Beginning at the center of the arena facing the left wall or fence.

1. Beginning on the right lead, complete three circles to the right: the first circle small and slow; the next two circles large and fast. Change leads at the center of the arena.
2. Complete three circles to the left: the first circle small and slow; the next two circles large and fast. Change leads at the center of the arena.
3. Continue around previous circle to the right. At the top of the circle, run down the middle to the far end of the arena past the end marker and do a right rollback—no hesitation.
4. Run up the middle to the opposite end of the arena past the end marker and do a left rollback—no hesitation.
5. Run past the center marker and do a sliding stop. Back up to the center of the arena or at least ten feet (three meters). Hesitate.
6. Complete four spins to the right. Hesitate.
7. Complete four spins to the left. Hesitate to demonstrate the completion of the pattern.

[R/AQHAP-2]

Pattern Provided by:

Jitka Kynclova

WRC Prosper Celadna

Mladez Showmamship

Show Date: 09-03-2022

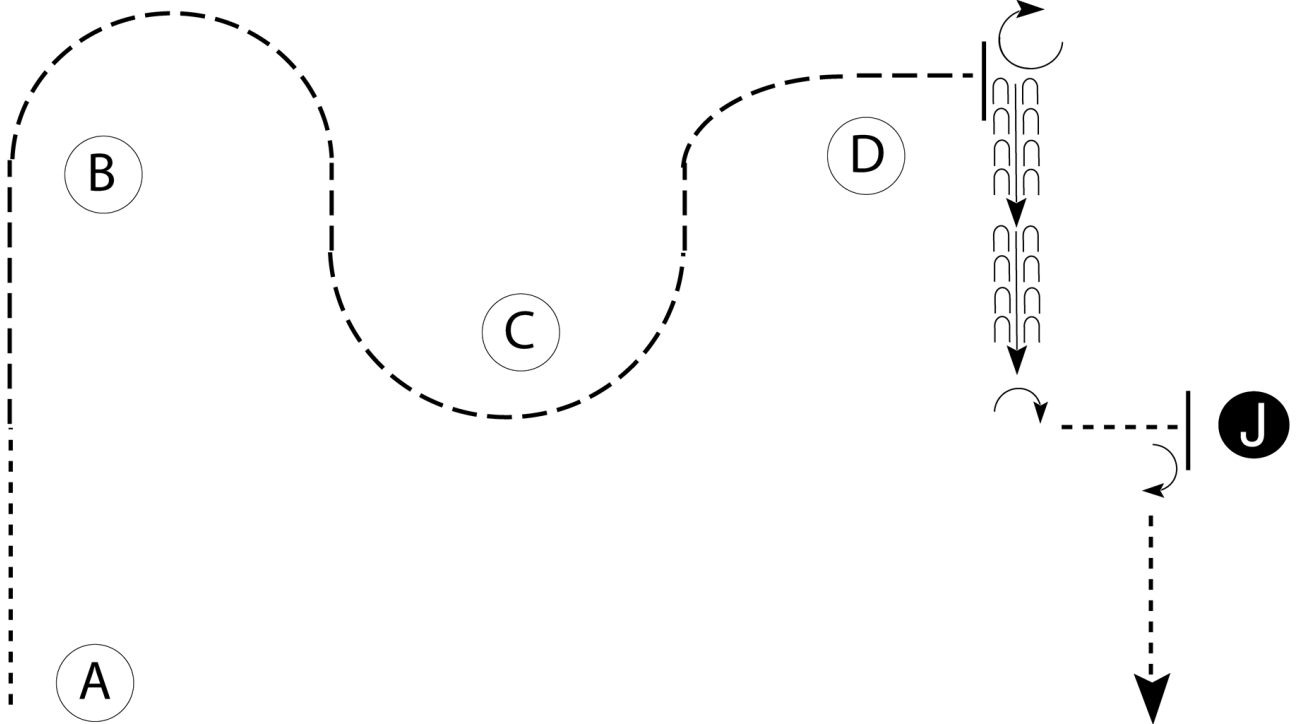

Be ready at A.

1. Walk from A halfway to B.
2. Trot around markers B, C and past D.
3. Stop. Perform a 270 degree turn.
4. Back.
5. Perform a 90 degree turn and walk to the judge.
6. Stop and set up for inspection.
7. When dismissed, perform a 1/4 turn and walk away.

Follow the instructions of your ring steward.

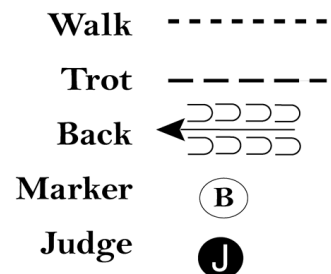

[S/1-74]

Pattern Provided by:

Jitka Kynclova

WRC Prosper Celadna

Amater showmanship

Show Date: 09-03-2022

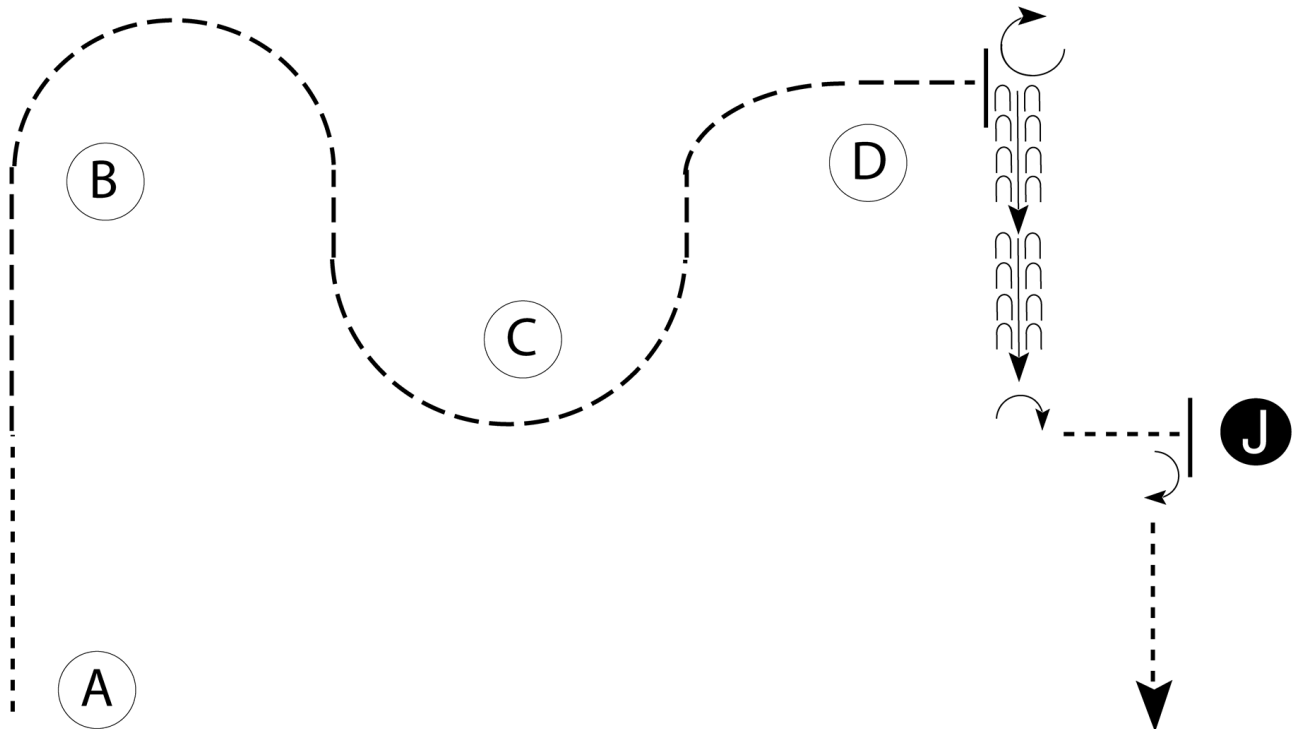

Be ready at A.

1. Walk from A halfway to B.
2. Trot around markers B, C and past D.
3. Stop. Perform a 270 degree turn.
4. Back.
5. Perform a 90 degree turn and walk to the judge.
6. Stop and set up for inspection.
7. When dismissed, perform a 1/4 turn and walk away.

Follow the instructions of your ring steward.

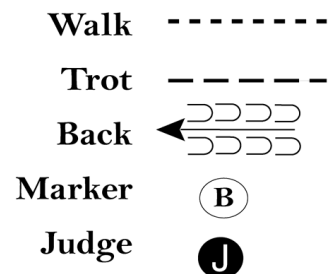

[S/1-74]

Pattern Provided by:

Jitka Kynclova

WRC Prosper Celadna

Open Showmanship

Show Date: 09-03-2022

www.HorseShowPatterns.com

www.HorseShowPatterns.com

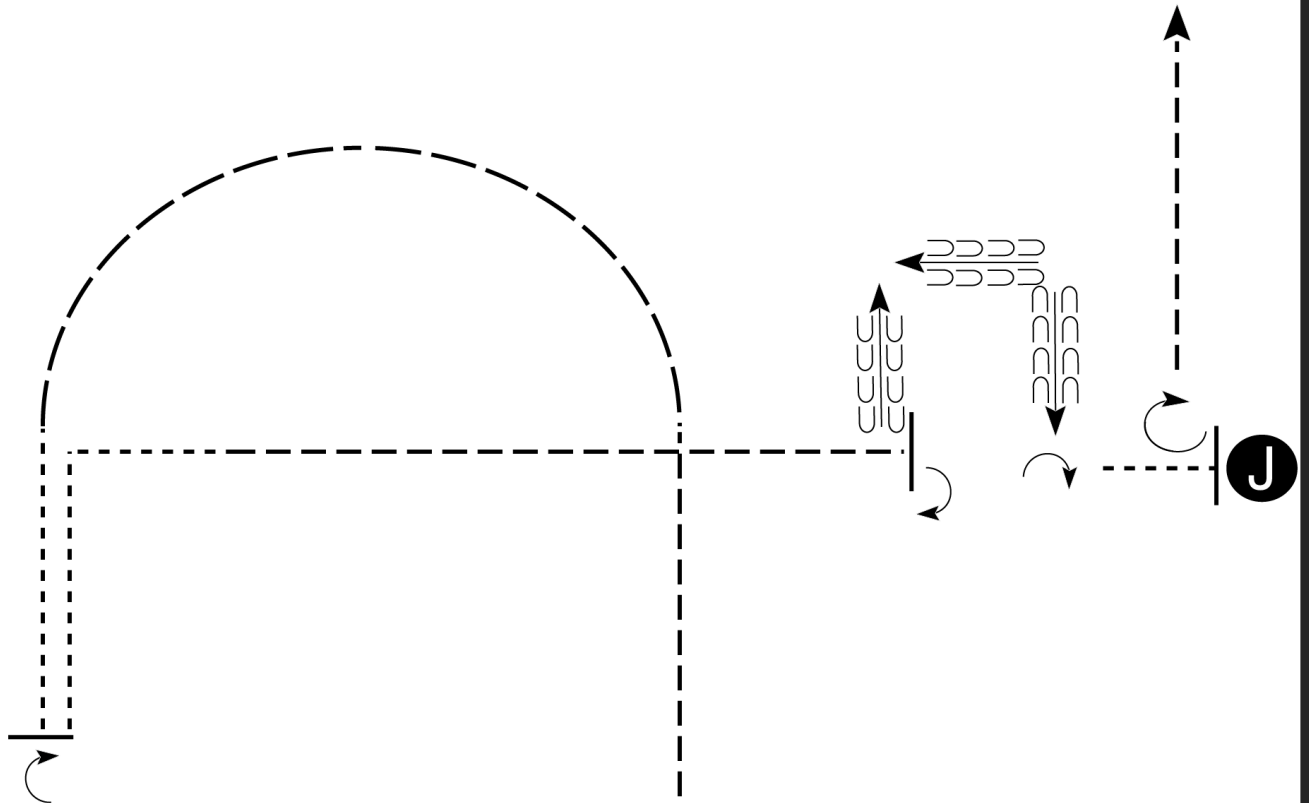

Be before at A.

A

1. Walk to A. Trot in a straight line then extend the trot in a half circle. Break to a walk and walk 3 strides.
2. Stop and perform a 1/2 turn.
3. Set up and present horse.
4. Walk a square corner then trot across center line.
5. Stop, perform a 90 degree turn then back a "U" as shown.
6. Perform a 1/4 turn then walk to Judge.
7. Stop and set up for inspection. When dismissed, perform a 3/4 turn and trot straight away.

- Walk -----
- Trot - - - - -
- Back ← ← ← ← ←
- Marker (B)
- Judge (J)

[S/2-113]

Pattern Provided by:
Jitka Kynclova

WRC Prosper Celadna

Pidilidi showmanship

Show Date: 09-03-2022

w w w . H o r s e S h o w P a t t e r n s . c o m

w w w . H o r s e S h o w P a t t e r n s . c o m

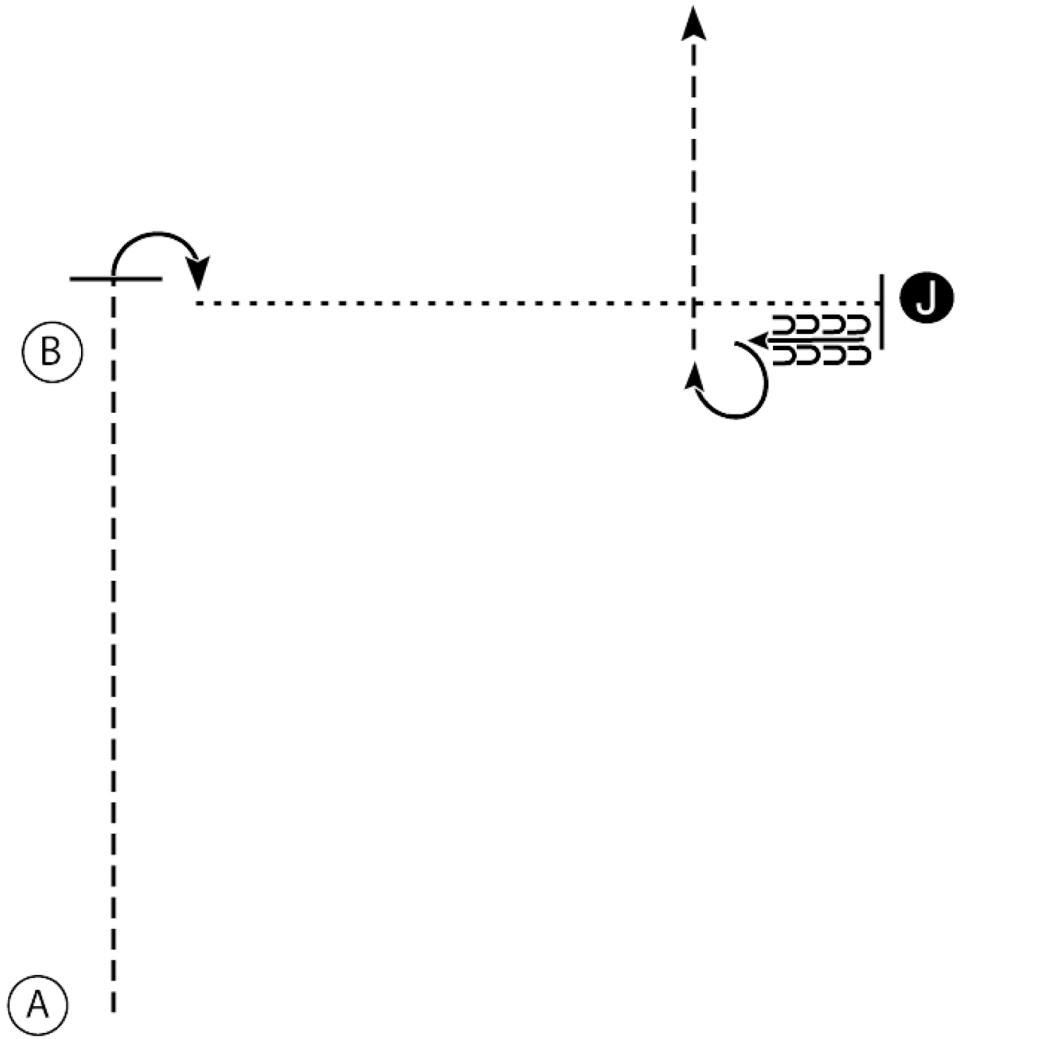

1. Begin at A. Trot from A past B
2. Stop and perform a 90 degree turn
3. Walk to the Judge, stop and set up for inspection
4. When dismissed back one horse length and perform a 270 degree turn
5. Trot to the line-up

Walk
Trot - - - - -
Back ← ← ← ← ←
Marker (B)
Judge (J)

[SWT-3]

Pattern Provided by:
Jitka Kynclova

WRC Prosper Celadna

Mladez Horsemanship

Show Date: 09-03-2022

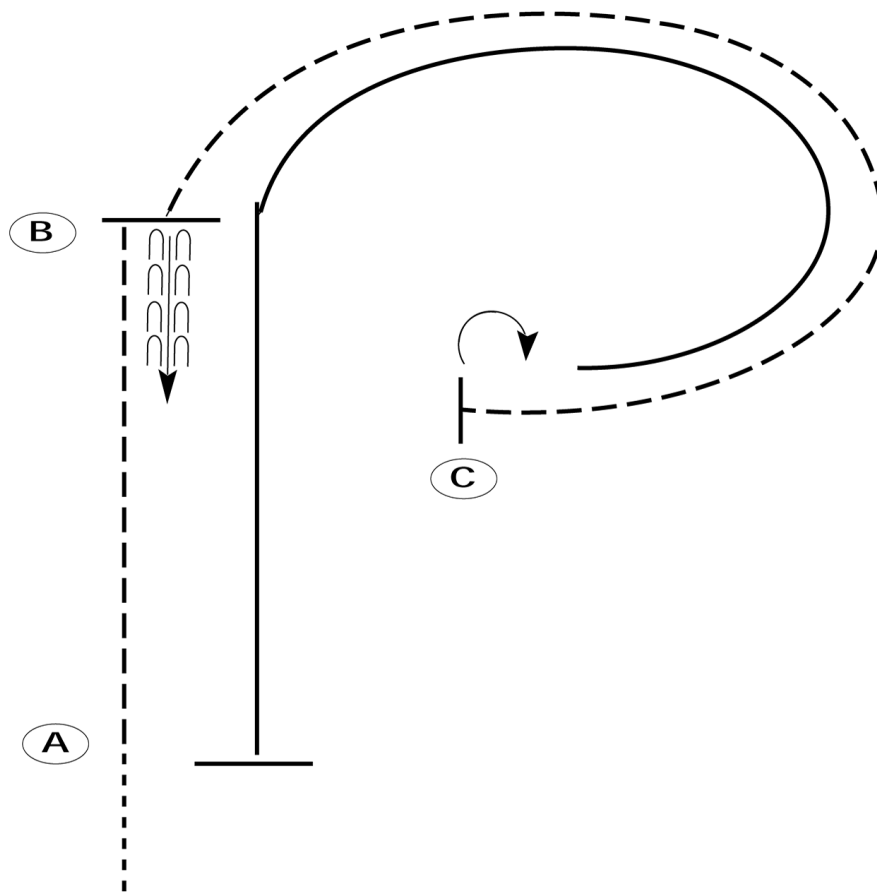

Be ready before A.

1. Walk to A.
2. Jog to B.
3. Stop at B and back approximately one horse length.
4. Jog to C.
5. Stop at C and turn 180 degrees to the right.
6. Lope on the left lead past B and to A.
7. Stop at A.

Follow the instructions of your ring steward.

Walk	-----
Jog	- - - - -
Extended Jog	- - - - -
Lope	—————
Leg Yield	
Lead Change	— / —
Back	← — — — — — — — — —
Marker	(B)
Sidepass	← — — — — →

[WH/1-49]

Pattern Provided by:

Jitka Kynclova

www.HorseShowPatterns.com

www.HorseShowPatterns.com

WRC Prosper Celadna

Amater Horsemanship

Show Date: 09-03-2022

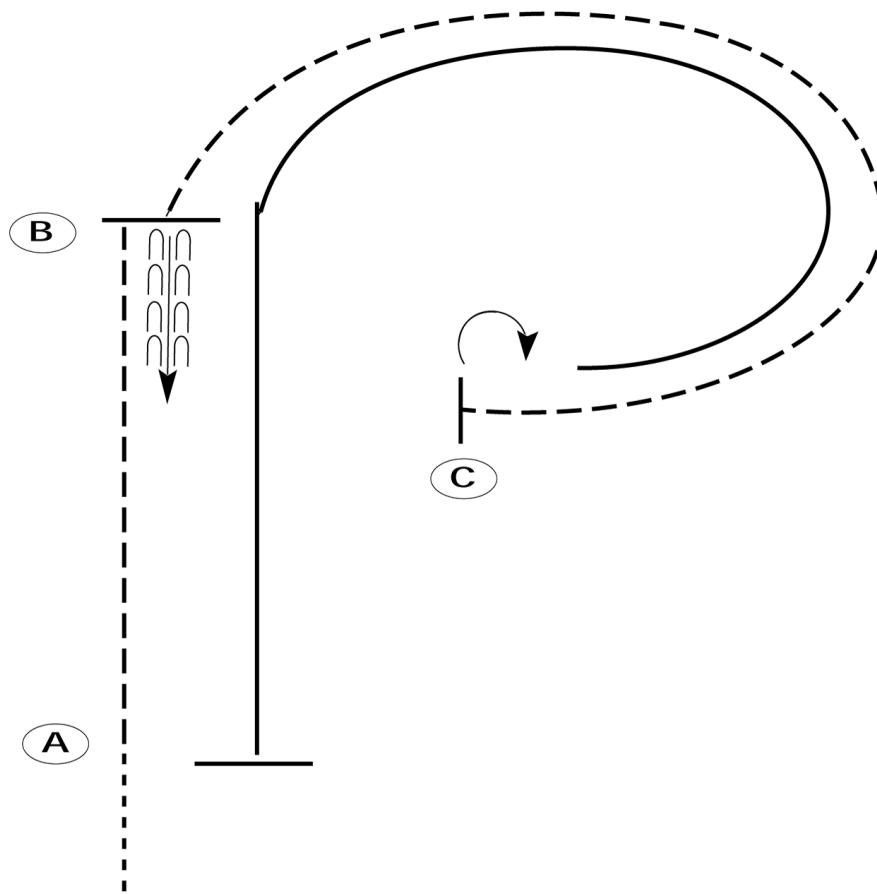

Be ready before A.

1. Walk to A.
2. Jog to B.
3. Stop at B and back approximately one horse length.
4. Jog to C.
5. Stop at C and turn 180 degrees to the right.
6. Lope on the left lead past B and to A.
7. Stop at A.

Follow the instructions of your ring steward.

Walk	-----
Jog	-----
Extended Jog	-----
Lope	—————
Leg Yield	
Lead Change	—/—
Back	←
Marker	(B)
Sidepass	←-----→

[WH/1-49]

Pattern Provided by:

Jitka Kynclova

www.HorseShowPatterns.com

www.HorseShowPatterns.com

WRC Prosper Celadna

Otevrena Western Horsemanship

Show Date: 09-03-2022

www.HorseShowPatterns.com

www.HorseShowPatterns.com

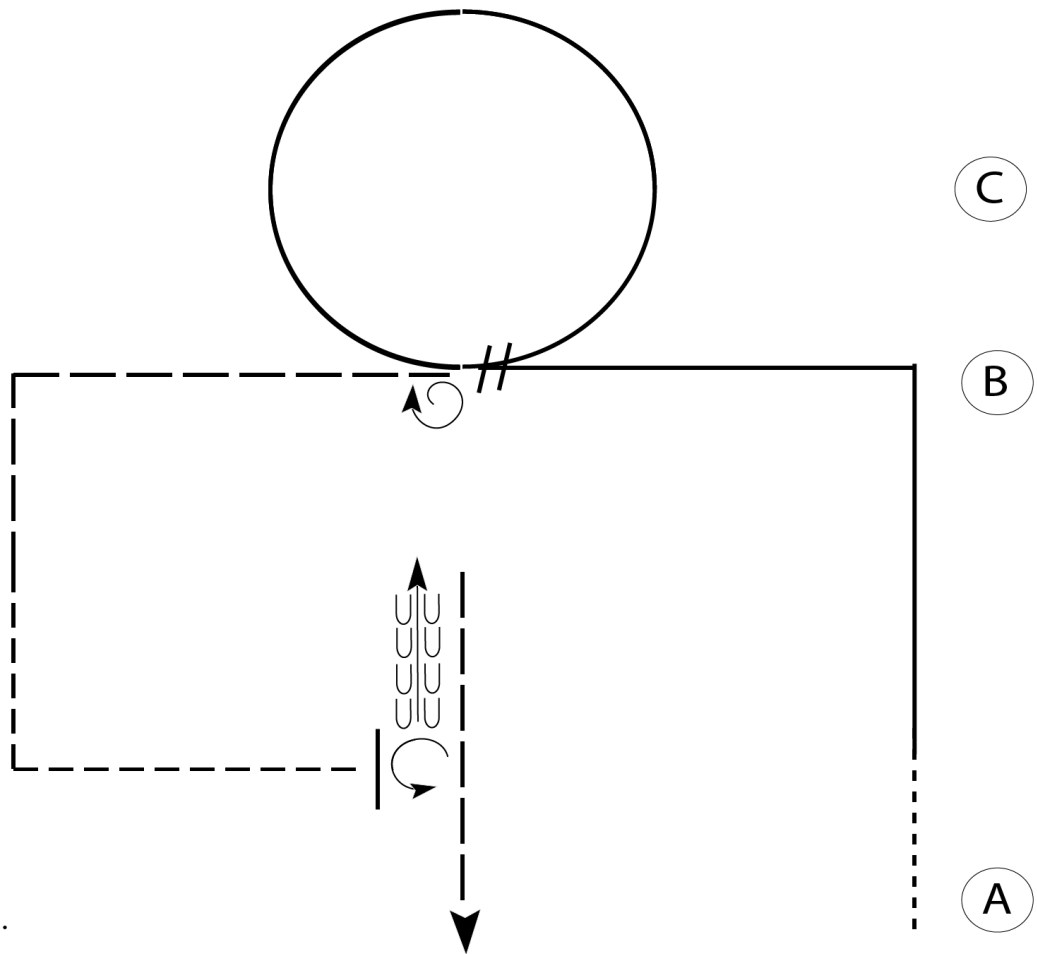

Be ready at A.

1. Walk approximately 2 horse lengths from A.
Lope on the left lead to B and lope a square corner
2. Perform a simple or flying lead change.
3. Lope a circle to the right.
4. Stop and perform a 360 degree turn to the right.
5. Extended jog thru first square corner. Slow to a jog midway and continue to jog through second corner.
6. Stop and perform a 270 degree turn to the left.
Back one horse length.
7. Pattern is complete. Exit at the extended jog.

Walk	-----
Jog	- - - - -
Extended Jog	— — — —
Lope	—————
Lead Change	— / —
Back	← ← ← ← ←
Marker	(B)

[WH/2-108]

Pattern Provided by:
Jitka Kynclova

WRC Prosper Celadna

Otevrena Western Riding

Show Date: 09-03-2022

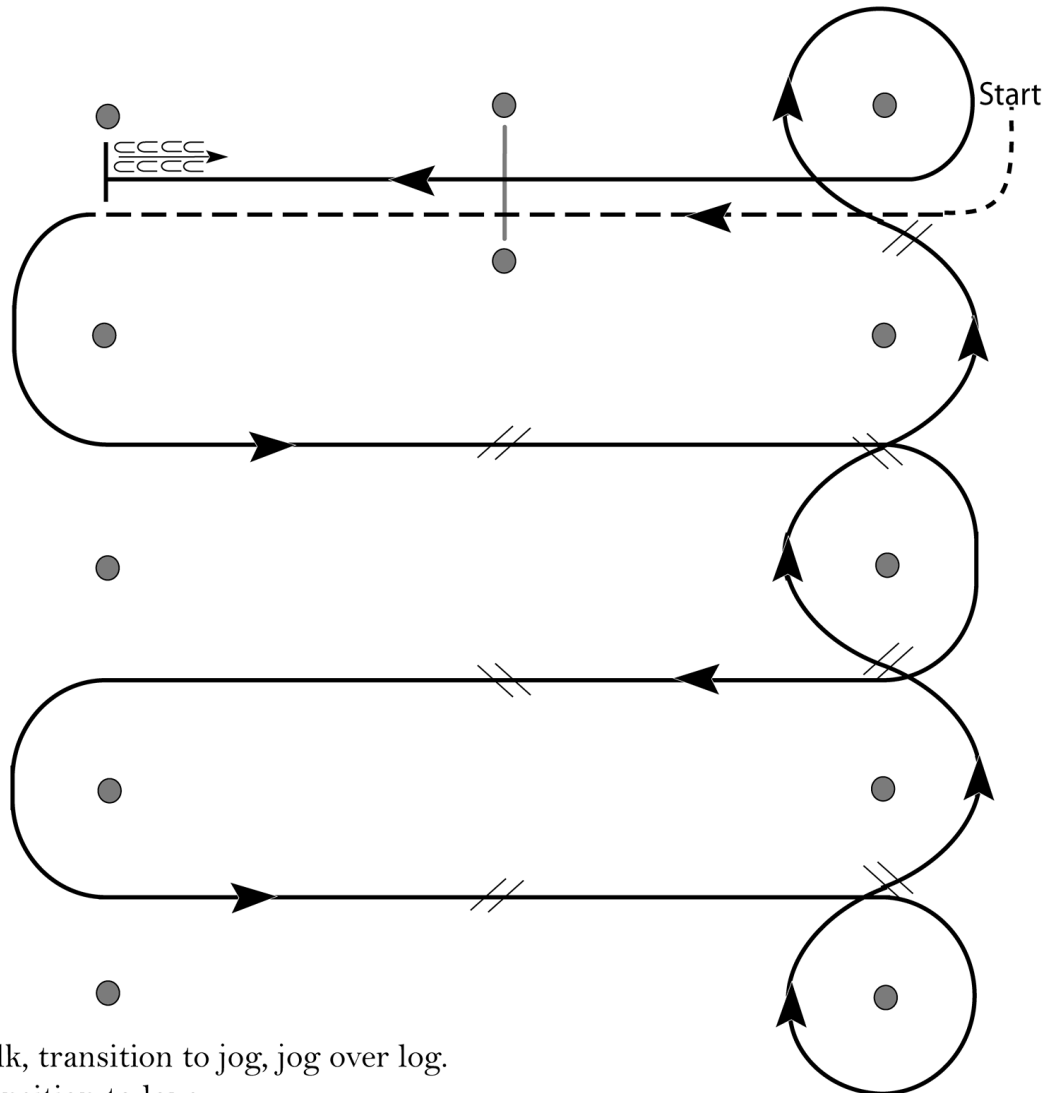

1. Walk, transition to jog, jog over lope.
2. Transition to lope.
3. First crossing change.
4. Second crossing change.
5. Third crossing change.
6. Circle and first line change.
7. Second line change.
8. Third line change.
9. Fourth line change and circle.
10. Lope lope.
11. Lope, stop and back.

[WR/OP-2]

Pattern Provided by:

Jitka Kynclova

WRC Prosper Celadna

Pidilidi horsemanship

Show Date: 09-03-2022

w w w . H o r s e S h o w P a t t e r n s . c o m

w w w . H o r s e S h o w P a t t e r n s . c o m

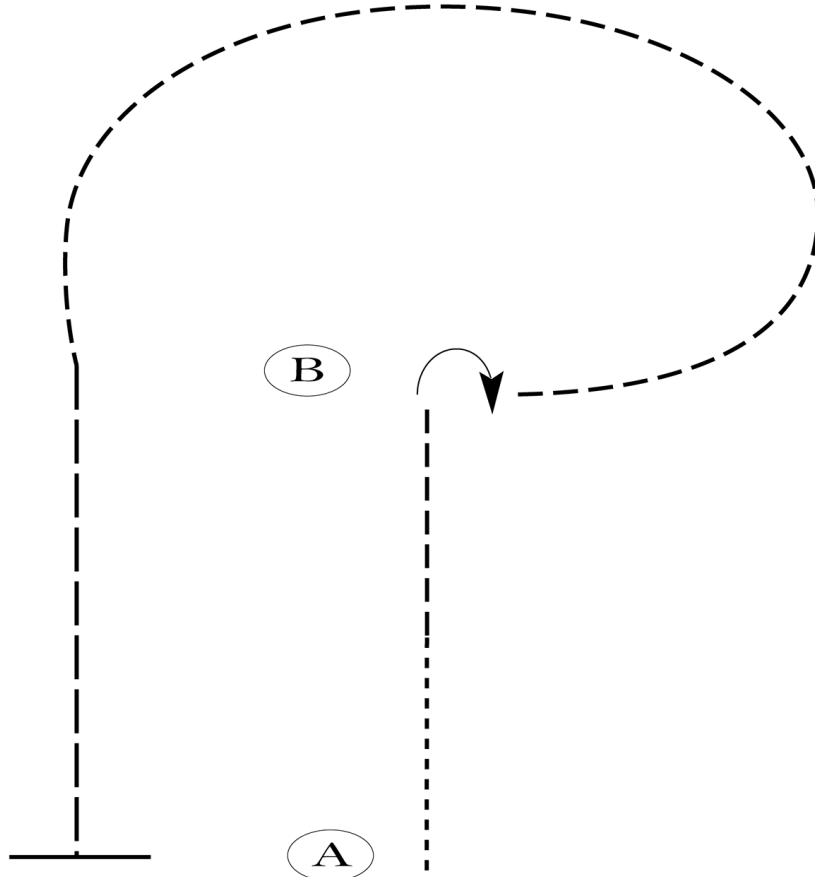

Be ready at A.

1. Walk half way to B.
2. Jog to B.
3. Turn 90 degrees to the right.
4. Jog around B.
5. When even with B, extend the jog to A.
6. Stop at A.

Follow the instructions of your ring steward.

Walk	-----
Jog	- - - - -
Extended Jog	- - - - -
Lope	—————
Leg Yield	
Lead Change	— / —
Back	← — — — —
Marker	⊙ B
Sidepass	← — — — — →

[WH/WT-38]

Pattern Provided by:

Jitka Kynclova